

kendo

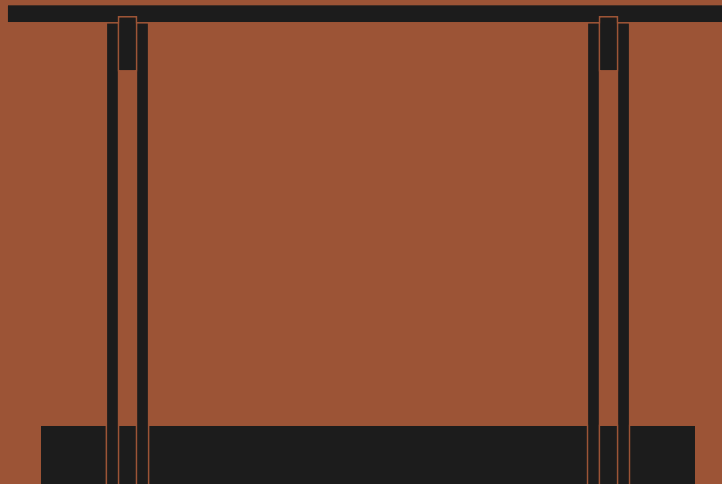

RAK

Desk

Designed by *Francesc Rifé Studio*

Rak

Francesc Rifé Studio

Escritorio compuesto por una tapa y una estructura en MDF chapado en fresno. La tapa cuenta con una separación de 4mm en el centro para ofrecer una mayor ligereza. El mueble dispone, además, de dos travesaños en la unión de la estructura con la tapa y otro travesaño en la parte inferior, ambos en fresno macizo, que aportan solidez al conjunto.

Desk consisting of a rectangular top and structure in ash veneered MDF. The top has a 4mm separation gap across its centre to offer greater lightness. The desk also possesses two crossbars at the intersection between structure and top, and another crossbar at the bottom, both in solid ash wood, which provide strength to the whole.

Escritorio Desk

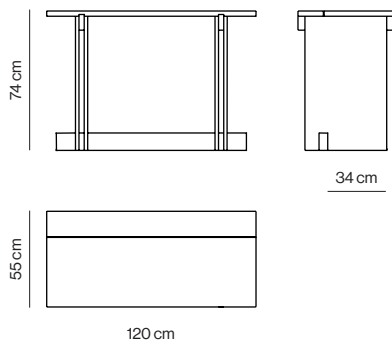

RAKE-25

120x55x74 cm

0,654 m³ 43 Kg

Fresno
Ash

Acabados | Finishes

Colores aproximados
Approximate colours

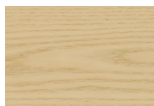
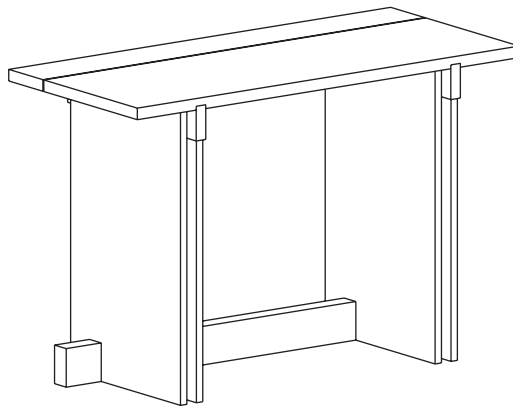

Fresno natural
Natural ash



Fresno ceniza
Grey ash

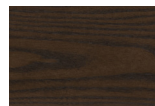

Fresno tostado
Toasted ash

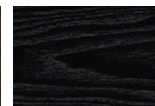

Fresno negro
Black ash

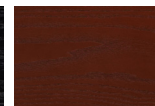

Fresno burdeos
Burgundy ash



Fresno verde
Green ash



Fresno azul
Blue ash